

# POTAIN

# MC 78

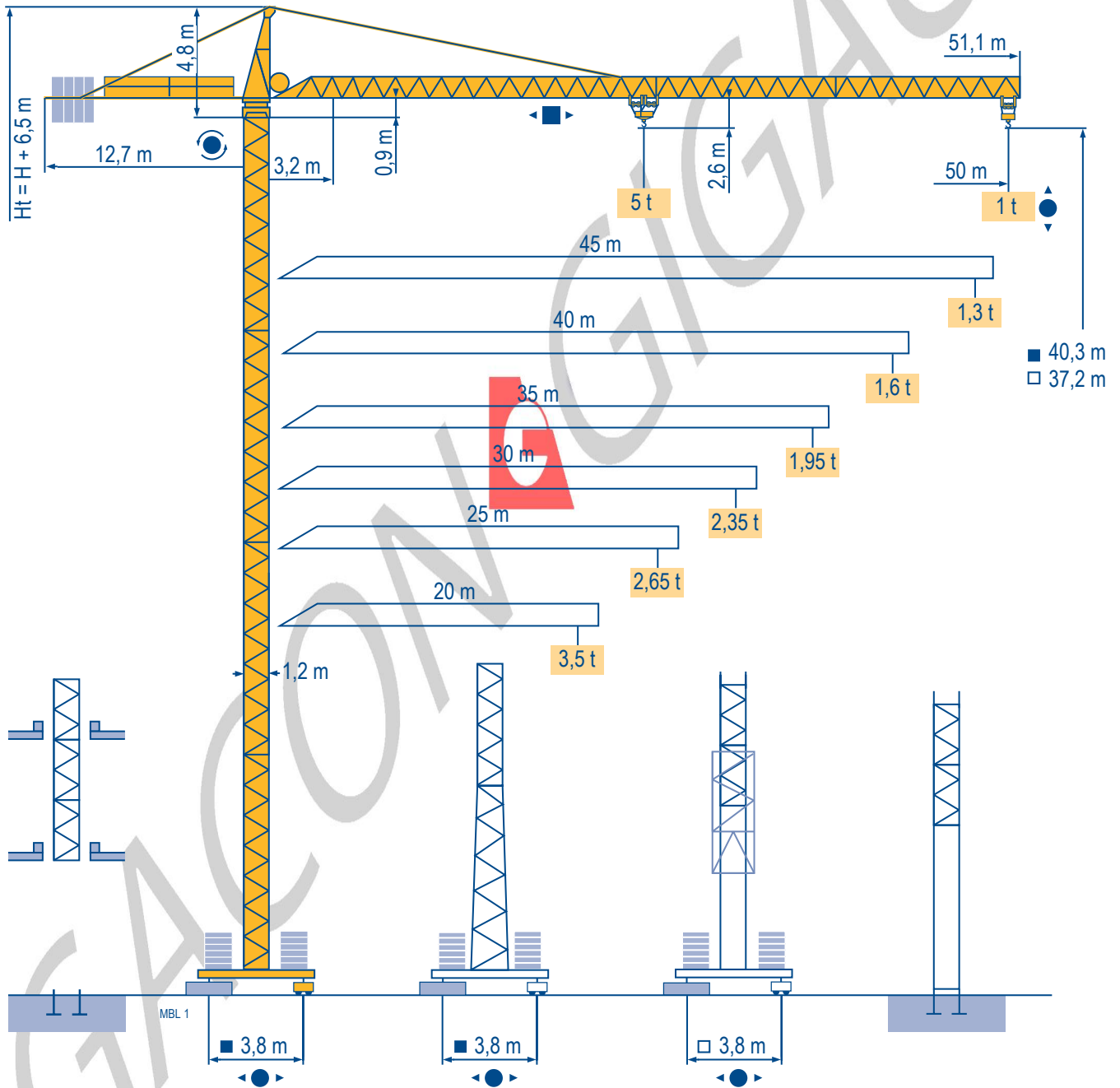

## CITY CRANE

CE FEM 1.001-A3

Mat / Réactions  $\square$  1,2 m

Maste /  
Eckdrücke  
Masts /  
Reactions  
Mástil /  
Reacciones  
Torre / Reazioni  
Tramo /  
Reações

MBL 2

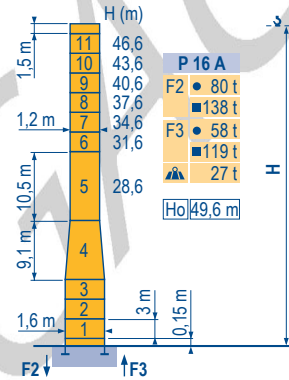
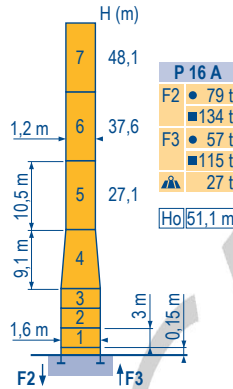
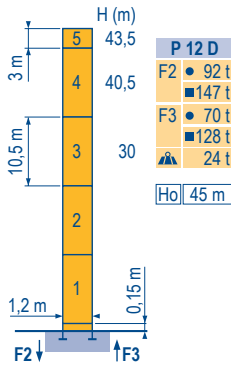
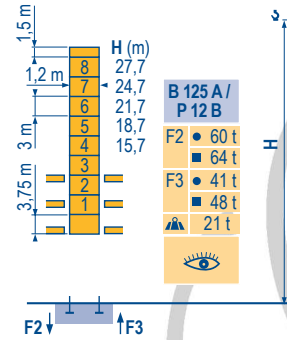
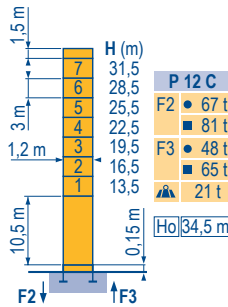
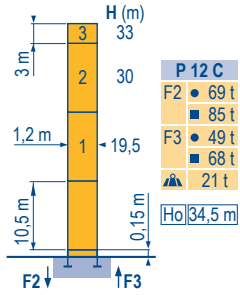

$\square$  1,2 m  
20 m  $\Rightarrow$  50 m

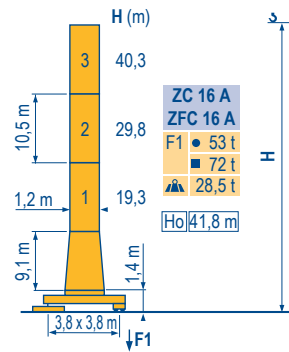
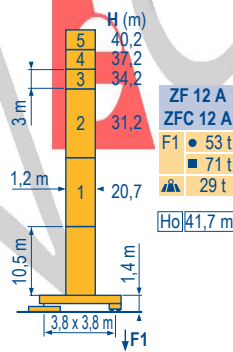
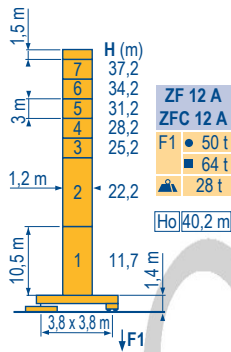

ZF - ZC - ZFC

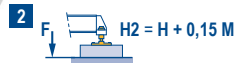

CITY CRANE  
MC 78

POTAIN

- Réactions en service
- Réactions hors service
- A vide sans lest (ni train de transport) avec flèche et hauteur maximum.
- Ho** H sans cabine

- D** Reaktionskräfte in Betrieb
- Reaktionskräfte außer Betrieb
- Ohne Last, Ballast (und Transportachse), mit Maximalausleger und Maximalhöhe.
- H Ohne Fahrerhaus

- GB** Reactions in service
- Reactions out of service
- Without load, ballast (or transport axles), with maximum jib and maximum height.
- H without cab

- E** Reacciones en servicio
- Reacciones fuera de servicio
- Sin carga, sin lastre, (ni tren de transporte), flecha y altura máxima.
- H sin cabina

- I** Reazioni in servizio
- Reazioni fuori servizio
- A vuoto, senza zavorra (ne assali di trasporto) con braccio massimo e altezza massima.
- H senza cabina

- P** Reações em serviço
- Reações fora de serviço
- Sem carga (nem trem de transporte) - sem lastro com lança e altura máximas.
- H sem cabine

Courbes de charges  
Lastkurven  
Load diagrams  
Curvas de cargas  
Curve di carico  
Curva de cargas

MBL 1

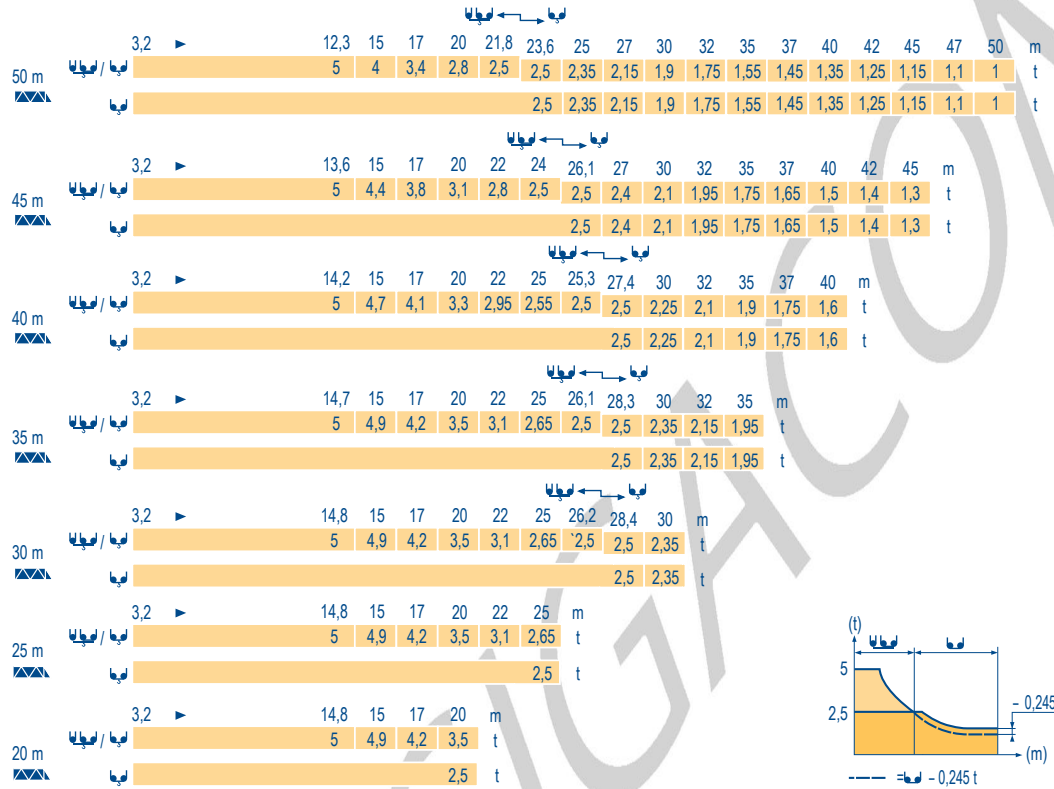

Télescopage sur dalles  
Kletterkrane im Gebäude  
Climbing crane  
Telescopage gruas trepadoras  
Gru in cavedio  
Telescopagem sobre lages

MBL 1

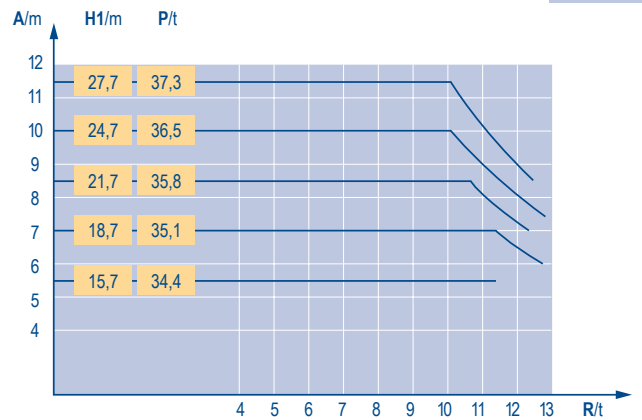
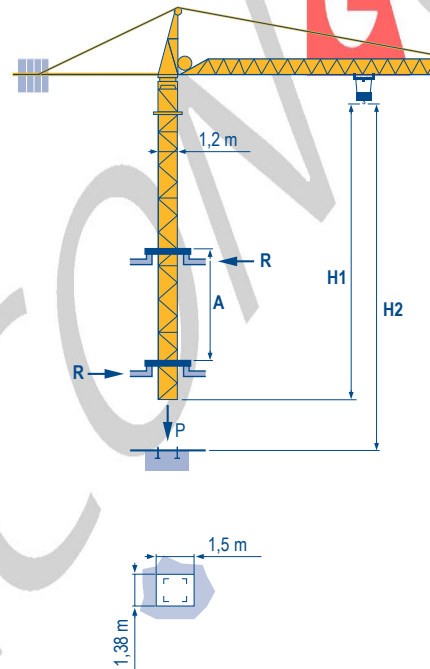

B 125 A















CITY CRANE  
MC 78

POTAIN

	F	D	GB	E	I	P
<b>A</b>	Distance entre cadres	Abstand zwischen den Rahmen	Distance between collars	Distancia entra marcos	Distanza fra i telai	Distância entre quadros
<b>H1</b>	Hauteur grue	Kranhöhe	Crane height	Altura grúa	Altezza gru	Altura da grua
<b>P</b>	Poids de la grue(en service)	Krangewicht (in Betrieb)	Crane weight (in service)	Peso de la grúa (en servicio)	Peso della gru (in servizio)	Peso da grua (em serviço)
<b>R</b>	Réaction horizontale	Horizontalkräfte	Horizontal reaction	Reaccion horizontal	Reazione orizzontale	Reacção horizontal
	Voir télescopage sur dalles	Siehe Kletterkrane im Gebäude	See climbing crane	Veja grua trepadora	Consultare gru in cavedio	Ver telescopagem sobre lages

Mécanismes  
Antriebe  
Mechanisms  
Meccanismi  
Mecanismos

MBL 2

			U			UU			ch - PS hp	kW	
											
	15 PC 13-6	m/min	7,2	21,5	43	3,6	11	21,5	15	11	185 m
		t	2,5	2,5	1,3	5	5	2,6			
	25 PC 13-8	m/min	8,2	33	66	4,1	16,5	33	25	18	323 m
		t	2,5	2,5	1,3	5	5	2,6			
	20 LVF 13	m/min	5 → 28,4 → 52,6 → 69			2,5 → 14,4 → 26,3 → 34,5			20	15	323 m
		t	2,5	2,5	1,3	0,65	5	5			
	4 D3 V3	m/min	15 - 30 - 58						4	3	
	RVCV 60	tr/min U/min rpm	0 → 0,8						8	6	
	ZF TVD 324	m/min	26						2 x 4	2 x 2,9	
	ZC - ZFC RT 224	m/min	25						2 x 4	2 x 2,9	
CEI 38  IEC 38			kVA								
400 V (+6% -10%) 50 Hz			15 PC : 30 kVA 25 PC : 35 kVA 20 LVF : 30 kVA								

F

Levage  
Distribution  
Orientation  
Translation

D

Heben  
Katzfahren  
Schwenken  
Kranfahren

GB

Hoisting  
Trolleying  
Slewing  
Travelling

E

Elevación  
Distribución  
Orientación  
Traslación

I

Sollevamento  
Distribuzione  
Rotazione  
Traslazione

P

Elevação  
Distribuição  
Rotação  
Translação



Document commercial non contractuel. Pour toute information technique se référer à la notice correspondante.

Unverbindliches Vertriebsdokument. Für technische Informationen, siehe die entsprechenden Anweisungen.

This commercial document is not legally binding. For any technical information, please refer to the corresponding instructions.

Documento comercial non contractuel. Para cualquier información técnica, ver la noticia correspondiente.

Documento commerciale non vincolante, per tutte le informazioni tecniche fare riferimento al catalogo istruzioni.

Documento comercial não contratual. Para qualquer informação técnica complementar consultar as respectivas instruções.

**Manitowoc**  
Crane CARE

**POTAIN**  
Manitowoc Crane Group



Americas

Tel : +1 888 479 7278  
Tel : +1 717 593 2000

Europe - Middle East - Africa

Tel : +33 (0) 4 72 81 50 00  
Tel : +44 (0) 191 522 2000

Asia - Pacific

Tel : +65 6264 1188  
Fax : +65 6862 4142

www.manitowoccrane.com

18, rue de Charbonnières - B.R.173  
69132 ECULLY Cedex - France

Tél. : +33 (0) 4 72 18 20 20  
Fax. : +33 (0) 4 72 18 20 00  
www.manitowoccrane.com

**CITY CRANE MC 78**

Réf. 2004 39 MBL 3

Copyright.Reproduction interdite © POTAIN 2004